

# CAPRI H48 / 18.9

Designed by iSiMAR

Collection made of galvanized wire, polyester powder coated. The materials we use are durable, suitable for intensive use and weather-resistant. The CAPRI collection is perfect for indoor, outdoor and contract use. Our materials are noble, 100% recycled and recyclable, and environmentally friendly.

Colección fabricada en varilla de acero galvanizado y lacado con polvo de poliéster. Nuestros materiales son aptos para el uso intensivo y resistentes a las inclemencias del tiempo. Perfectos para uso interior, exterior y contract. Asimismo, nuestros materiales son nobles, 100% reciclados y reciclables y responsables con el medio ambiente.



## Technical specifications / Especificaciones técnicas

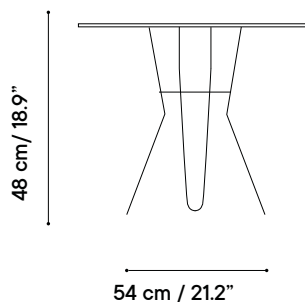



Metal or HPL table top

iSi 9000	ø 60 x 48 cm / 23.6" x 18.9"
iSi 9042	ø 70 x 48 cm / 27.6" x 18.9"
iSi 9043	ø 80 x 48 cm / 31.5" x 18.9"
iSi 9044	ø 90 x 48 cm / 35.4" x 18.9"
iSi 9045	60 x 60 x 48 cm / 23.6" x 23.6" x 18.9"
iSi 9046	70 x 70 x 48 cm / 27.5" x 27.5" x 18.9"
iSi 9047	80 x 80 x 48 cm / 31.5" x 31.5" x 18.9"
iSi 9048	90 x 90 x 48 cm / 35.4" x 35.4" x 18.9"

DATE 2016

 Indoor & outdoor / Interior y exterior

 Galvanized wire / Varilla galvanizada

 Weight capacity / Peso máximo > 250 kg / 552 lb

 6 - 11 kgs / 13.2 - 24.2 lbs

 2 units/box

 12 units/pallet

 UNE-EN 581-1 y 581-2

## Custom options / Customización

### Frame / Estructura

Select the color of the frame from our 32 metal finishes for indoor & outdoor use.

Color de la estructura a elegir entre 32 acabados metálicos, aptos para interior y exterior.

### Table-top / Tablero

Select the table-top among 32 metal finishes (same as the frame) / 15 HPL

A elegir entre 32 acabados metalizados (igual a la estructura) / 15 acabados compacto.

# MATERIALS

## Galvanized wire & steel / Varilla y chapa de acero galvanizado

Specifications suitable for outdoor use and intensive use. Manufactured under UN-EN 16120-2, 10218-2, 10244-2 & UNE-EN 10346.

Table-top width: 15 mm / 0.6 in.

Especificaciones aptas para uso exterior y uso intensivo. Fabricado bajo normas UN-EN 16120-2, 10218-2, 10244-2 y UNE-EN 10346.

Grosor del tablero: 15 mm.



Galvanized wire C9D  
Acero galvanizado C9D



100% recycled and recyclable  
100% reciclado y reciclable



Galvanized steel DX51D - Z275  
Acero galvanizado DX51D - Z275



100% recycled and recyclable  
100% reciclado y reciclable

## Paints / Pinturas

We use a texturized matte polyester powder coat specifically for galvanized steel and aluminium which is compliant with regulations for exterior and contract use. Excellent mechanical properties and resistance to outdoor. It respects the environment and complies with the European Directive on "Restriction of the use of certain hazardous substances".

Neutral salt spray test: C5H - ISO 12944-2/6 (Qualisteelcoat).

Utilizamos recubrimiento en polvo poliéster texturado y mate específico para acero galvanizado y aluminio. Cumple con normativa para uso exterior y contract. Excelentes propiedades mecánicas y resistencia a la intemperie. Respeto el medio ambiente y cumple con la Directiva Europea de "Restriction of the use of certain hazardous substances".

NSS Test: C5H - ISO 12944-2/6 (Qualisteelcoat).



Suitable for outdoor  
Apto para exterior



Protection against rust  
Resistentes a la corrosión



UV Resistant  
Protege contra los rayos UVA



Mechanical properties:  
grip / impacts  
Propiedades mecánicas:  
adherencia / impactos



## HPL table-top / Tablero compacto

High pressure laminated boards with excellent qualities for contract use, exterior, public places or cases with necessary level of hygiene (hospitals, kitchens, etc).

Width: 10 mm / 0.39 in.

Tableros laminados de alta presión con excelentes cualidades para uso contract, exterior, lugares públicos o casos con necesario nivel de higiene (hospitales, cocinas, etc).

Grosor del tablero: 10 mm.



Impact resistant  
Resistente al impacto



Thermal-resistant  
Termorresistente



UV Resistant  
Protege contra los rayos UVA



Easy to clean and maintain  
Fácil limpieza y mantenimiento



High Durability  
Alta durabilidad



UV and friction resistant  
Resistentes a los rayos UV y al rozamiento





# FINISHES

## Metal finishes / Acabados metálicos

												
Ibiza white RAL 9016	Beige cream RAL 1013	Natural honey RAL 9016	Geranium red RAL 3020	Tomato red RAL 3013	Red wine RAL 3004	Pastel pink RAL 3012	Paradiso pink	Pastel violet RAL 4009	Plain blue RAL 5002	Navy blue RAL 5011	Ultramarine blue RAL 5009	Agata blue RAL 5018
												
Turquoise blue RAL 6027	Pastel green RAL 6019	Pale green RAL 6021	Khaki green	Emerald green	Pine green RAL 6005	Clay	Brown chocolate RAL 8017	Taupe grey RAL 7006	Sand beige RAL 7032	Light grey RAL 9006	Stone grey RAL 7046	Anthracite grey RAL 7016
												
Polar ash	Gold supreme	Bronze	Manganese	Industrial	Night black RAL 9011							

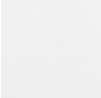
## HPL Table-top / Tablero compacto

	
White	Black

## Wood solid core

	
Wafer	Valdweg