

MARTINI table

Designed by Lagranja Design

Collection made of galvanized wire, polyester powder coated. The materials we use are durable, suitable for intensive use and weather-resistant. The MARTINI collection is perfect for indoor, outdoor and contract use. Our materials are noble, 100% recycled and recyclable, and environmentally friendly.

Colección fabricada en varilla de acero galvanizado y lacado con polvo de poliéster. Nuestros materiales son aptos para el uso intensivo y resistentes a las inclemencias del tiempo. Perfectos para uso interior, exterior y contract. Asimismo, nuestros materiales son nobles, 100% reciclados y reciclables y responsables con el medio ambiente.



Technical specifications / Especificaciones técnicas

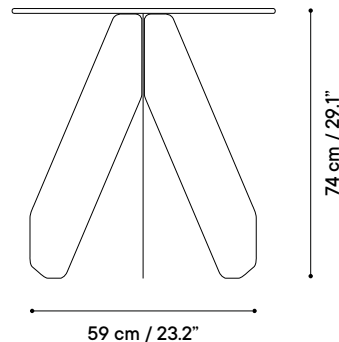

Metal or HPL table top

iSi 8219	ø 60 x 74 cm / 23.6" x 29.1"
iSi 8220	ø 70 x 74 cm / 27.6" x 29.1"
iSi 8221	ø 80 x 74 cm / 31.5" x 29.1"
iSi 8222	ø 90 x 74 cm / 35.4" x 29.1"
iSi 8223	ø 100 x 74 cm / 39.4" x 29.1"
iSi 8224	ø 110 x 74 cm / 43.2" x 29.1"
iSi 8225	60 x 60 x 74 cm / 23.6" x 23.6" x 29.1"
iSi 8226	70 x 70 x 74 cm / 27.6" x 27.6" x 29.1"
iSi 8227	80 x 80 x 74 cm / 31.5" x 31.5" x 29.1"
iSi 8228	90 x 90 x 74 cm / 35.4" x 35.4" x 29.1"

DATE 2023

 Indoor & outdoor / Interior y exterior

 Galvanized wire / Varilla galvanizada

 Stackable / Apilable

 Weight capacity / Peso máximo > 250 kg / 552 lb

 16 kgs / 35.27 lb

 1 units/box

 UNE-EN 581 - 1 and 581 - 2

 Cushion available / Cojín disponible

Custom options / Customización

Frame / Estructura

Select the color of the frame from our 32 metal finishes for indoor & outdoor use.

Color de la estructura a elegir entre 32 acabados metálicos, aptos para interior y exterior.

Table-top / Tablero

Select the table-top among 32 metal finishes (same as the frame) / 7 porcelains / 8 HPL / 80 MDF designer edition

A elegir entre 32 acabados metalizados (igual a la estructura) / 7 acabados porcelánicos / 8 acabados compacto / 80 acabados MDF

MATERIALS

Galvanized wire / Varilla de acero galvanizado

Specifications suitable for outdoor use and intensive use. Manufactured under UN EN-16120-2, 10218-2, 10244-2 standards.

Especificaciones aptas para uso exterior y uso contract. Fabricado bajo normas UN EN-16120-2, 10218-2, 10244-2.



Galvanized wire C9D
Varilla de acero galvanizado C9D



100% recycled and recyclable
100% reciclado y reciclable

Paints / Pinturas

We use a texturized matte polyester powder coat specifically for galvanized steel and aluminium which is compliant with regulations for exterior and intensive use. Excellent mechanical properties and resistance to outdoor.

It respects the environment and complies with the European Directive on "Restriction of the use of certain hazardous substances".

Neutral salt spray test: C5H - ISO 12944-2/6 (Qualisteelcoat).

Utilizamos recubrimiento en polvo poliéster texturado y mate específico para acero galvanizado y aluminio.

Cumple con normativa para uso exterior y contract. Excelentes propiedades mecánicas y resistencia a la intemperie.

Respeta el medio ambiente y cumple con la Directiva Europea de "Restriction of the use of certain hazardous substances".

NSS Test: C5H - ISO 12944-2/6 (Qualisteelcoat).



Suitable for outdoor
Apto para exterior



UV Resistant
Protege contra los rayos UVA



Protection against rust
Resistentes a la corrosión



Mechanical properties:
grip / impacts
Propiedades mecánicas:
adherencia / impactos



Porcelain table-top / Tablero porcelánico

The high performance porcelain tabletops, made of mineral base such as quartz, and all of its characteristics made them ideal for outdoor and contract use.

Width: 12 mm / 0.47 in.

Tablero porcelánico de altas prestaciones, fabricados a base de minerales como el cuarzo y con características idóneas para uso exterior y contract.

Grosor del tablero: 12 mm.



Water resistant
Repelente al agua



UV Resistant
Protege contra los rayos UVA



High Durability
Alta durabilidad



Natural & Recyclable
Natural y reciclable



Electrical insulator
Aislante eléctrico



Easy to clean and disinfect
Fácil limpieza y desinfección



UV, fire and friction resistant
Resistentes rayos UV, fuego y rozamiento



HPL table-top / Tablero compacto

High pressure laminated boards with excellent qualities for contract use, exterior, public places or cases with necessary level of hygiene (hospitals, kitchens, etc).

Width: 10 mm / 0.39 in.

Tableros laminados de alta presión con excelentes cualidades para uso contract, exterior, lugares públicos o casos con necesario nivel de higiene (hospitales, cocinas, etc).

Grosor del tablero: 10 mm.



Impact resistant
Resistente al impacto



UV Resistant
Protege contra los rayos UVA



High Durability
Alta durabilidad



Thermal-resistant
Termorresistente



Easy to clean and maintain
Fácil limpieza y mantenimiento



UV and friction resistant
Resistentes a los rayos UV y al rozamiento



FINISHES

Metal finishes / Acabados metálicos



Porcelain Table-top / Tablero porcelánico

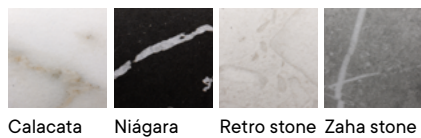

Calacata Niágara Retro stone Zaha stone

NEOLITH

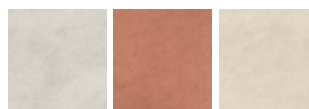

Albarium Kraftizen Umber Kraftizen Nacre Kraftizen

COSENTINO

HPL Table-top / Tablero compacto

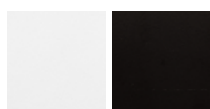

White Black

Wood solid core

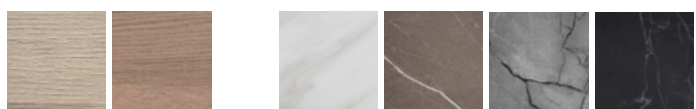

Wafer Valdweg Marmo Canova Pulpis Light Yule Grey Kandia Black

MATERIALS

MDF Water-repellent / MDF Hidrófugo

MDF Hydrophobic are wood fiberboards (MDF) for use in humid environments.

Wood fiberboard, MDF (Medium Density Fibreboard) and HDF (High Density Fibreboard), is a natural material of plant origin, derived from the processing of wood waste. The fiber is produced by pressing wood waste by adding glues or resins to keep the board compact.

Suitable for outdoor use: UNE-CEN/TR 581-4: 2006 IN
Surface resistance: UNE-EN 438-2

MDF Hidrófugo son tableros de fibras de madera (MDF) para uso en ambiente húmedo.

Los paneles de fibra de madera, MDF (Medium Density Fibreboard) y HDF (High Density Fibreboard), son un material natural de origen vegetal, procedente del procesamiento de residuos de madera. La fibra se produce presionando los desechos de madera mediante la adición de colas o resinas para mantener el tablero compacto.

Apto para exterior UNE-EN/ ISO 4892-2: 2014
Resistencia superficial: UNE-EB 438-2



Suitable for outdoor
Apto para exterior



UV Resistant
Protege contra los rayos UVA



High Durability
Alta durabilidad



Thermal-resistant
Termorresistente



Easy to clean and maintain
Fácil limpieza y mantenimiento



Impact and friction resistant
Resistente al impacto y al rozamiento



FINISHES

TILES COLLECTION

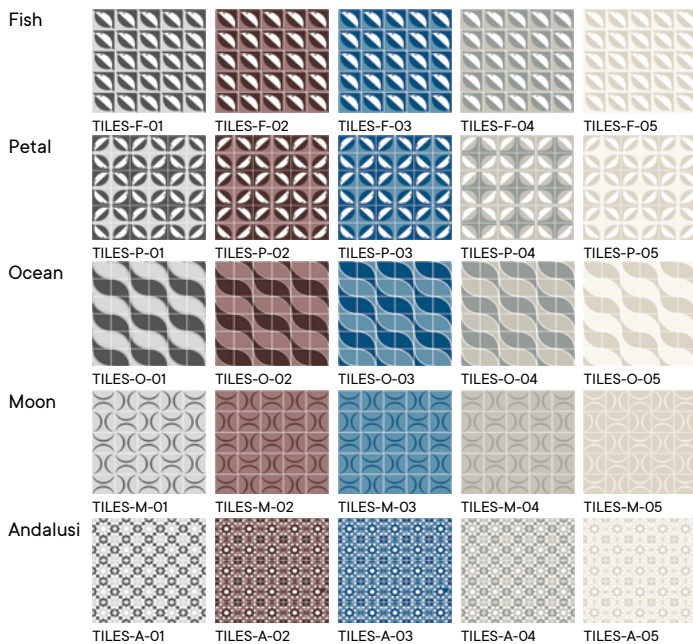

CLASSIC COLLECTION

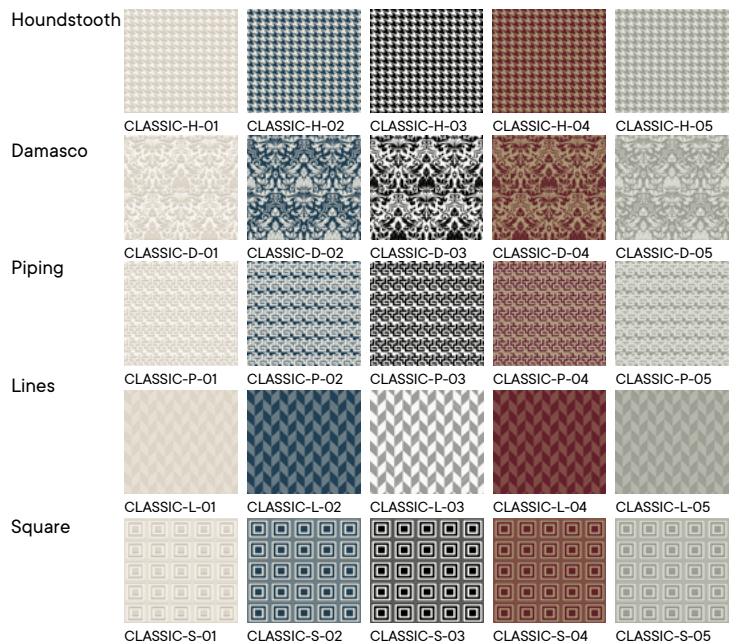

TEXTILE COLLECTION

